

harman kardon

MODEL TA-120

Recital II

COMBINED AM-FM TUNER AND 20 WATT POWER AMPLIFIER

OPERATION AND SERVICE INSTRUCTIONS

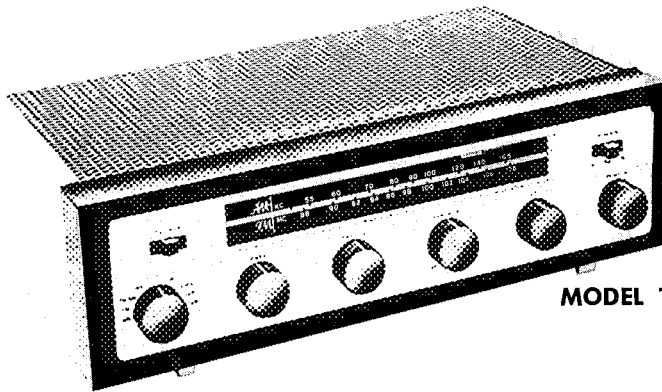

MODEL TA-120

More
Volume,
Tempo,
RCA
Extra-

all

UNPACKING

After unpacking the Recital II, inspect it carefully for any signs of damage in transit. Your unit was subjected to many inspections and tests, and then carefully packed. If any damage is visible, notify the transportation company at once.

Check the contents of the package carefully.

You should find:

- 1 Recital II, Model TA-120
- 1 Instruction Booklet
- 1 Warranty Card

It is strongly urged that the warranty card be completed and mailed without delay, to protect your rights under the warranty. If you should require repair service or information on the use of the Recital II, we will be able to identify your unit immediately, and respond quickly.

VENTILATION

All electrical equipment generates heat which must be allowed to escape. Although the Recital II is well ventilated in itself, sufficient space should be allowed around it to permit free air flow. If it is placed in a bookcase, it should be located well toward the front, to provide as much clearance as possible at the rear.

Do not put books or other objects on top of the Recital II. Covering the perforated tube grill will reduce the ventilation and result in sharply reduced component and tube life.

CONNECTIONS

AM ANTENNA

The Harman-Kardon ferrite loopstick, built into the Recital II, comprises all the antenna required for the finest in noise-free local AM reception. In locations more removed from metropolitan areas, an outdoor antenna may be required. This should consist of a single wire, as long as is reasonably practical, located away from large metal objects, power lines or electrical machinery. Connect one end to the AM terminal of the ANTENNA terminal strip on the rear of the chassis.

FM ANTENNA

A short length of ordinary wire, connected to the terminal marked FM will prove adequate in most installations. A loop of wire, approximately 36 inches long, connected between "FM" and "G" and hung inside the cabinet will prove useful in increasing the rejection of spurious signals. In those situations requiring an external FM antenna, connections should be made between "G" and "FM." A single dipole will be useful when stations to be received are located in opposite directions from each other. A non-directional dipole should be used if the stations are located in dispersed directions. A folded dipole antenna with reflector will provide maximum efficiency and may increase the number of distant FM stations your Recital II can receive.

POWER

Plug the power cord into any outlet furnishing 117 volts, 60 cycles house current. The exact voltage is relatively unimportant, and may vary between 105 and

HARMAN - KARDON, INC.

520 MAIN STREET, WESTBURY, L. I., N. Y.

125. Be sure, however, that you have 60 cycle AC power. A convenience outlet at the rear of the Recital II may be used for your record player which will then be turned on or off by the Recital II power switch.

PHONOGRAPH CONNECTIONS

Any type of record player will operate with the Recital II. To derive maximum enjoyment it is suggested that a high quality pickup cartridge and a rumble-free turn-table be used. Two classes of pickup cartridges are in general use: Magnetic (GE, Pickering, Fairchild, and Audak) and Crystal (including the newly developed ceramics). While any type of cartridge may be used it is strongly urged that the magnetic type be selected. It should be plugged into the receptacle marked "PHONO." Connect crystal or ceramic cartridges to the receptacle marked "AUX."

word of advice: The useful life of a phonograph is quite short, ranging from 15 minutes to several hours. In addition to degradation of tone quality the needle wears, the strong possibility exists that the records will be damaged if worn needles are promptly replaced. The purchase of a diamond, which has extremely long life, is therefore a worthwhile investment.

The power cord of the record player may be plugged into the auxiliary AC power outlet. It is sometimes advisable to ground the phonograph chassis to the receiver, to reduce hum or other unwanted noises. This may be accomplished by the use of any type of wire, one end connected to the "G" terminal of the "ANTENNA" or "SPEAKER" terminal strips, the other end connected to the metal framework of the phonograph.

AUXILIARY INPUT

An extra input is provided for auxiliary high level equipment such as a tape recorder or television tuner. This input is located on the rear of the chassis. If you are using a ceramic or crystal cartridge make certain to connect your phonograph output to this input.

TAPE OUTPUT

A receptacle marked "Tape Out" is located on the rear of the chassis. This is used to provide output to a tape recorder or other auxiliary equipment. Any program material appearing at the speaker terminals also appears at the "Tape Out" receptacle, but unmodified by the volume or tone controls. This makes it possible to record programs with the proper recording equalization (as determined by your tape recorder) while simultaneously listening to the program with the proper tone control, contour and loudness settings.

TAPE INPUT

Program material from a tape recorder or player may be connected into the Recital II in two different ways. If the tape player has a built-in amplifier or preamplifier, it should be connected to one of the auxiliary input

receptacles. If the tape player has no preamplifier, or if its amplifier is not of top quality, the tape head may be connected to the receptacle marked "TAPE INPUT". Setting the Function selector at the position marked with the appropriate speed will then provide the equalization recommended by the manufacturers of pre-recorded tape.

SPEAKER CONNECTIONS

A unique method of connecting one or two loudspeakers is incorporated in the Recital II in order that you derive maximum enjoyment from this superlative instrument with any of today's fine speaker systems.

For those using one speaker connect the speaker leads to terminals "G" and "A" on the three screw terminal strip at the rear of the chassis marked "SPEAKER." For speakers with an impedance of 12 to 24 ohms connect the Impedance Selector Jumper located at the rear of the chassis so that the jumper connects the middle terminal of the three screw terminal marked "IMPEDANCE SELECTOR" to the screw marked "16". For speakers with an impedance of from 4 to 12 ohms place the Impedance Selector jumper so that the middle terminal is connected to the screw marked "8". Tighten the terminal screws after the proper selection is made. The front panel Speaker Selector Switch should then be placed in position "A".

If you wish to feed two speakers with the Recital II and use either one or both together connect the second speaker to terminals "G" and "B" on the speaker terminal strip. For best operation both speakers should have the same impedance, although a slight mismatch will not affect the overall response. To select speaker A slide the front panel Speaker Selector Switch to position "A." To select speaker B slide the switch to position "B." To feed both speakers at the same time slide the switch to the position marked "AB." Due to the fact that the Speaker Selector Switch changes the transformer connections as well as the speaker connections in any position either or both speakers will be fed at the correct matching impedance and optimum results will be obtained.

A jumper wire is connected between A & B on the speaker terminals at the rear of this chassis. Be sure that this jumper is left connected when only one speaker system is used.

This connecting wire should only be removed when two different speaker systems are used. This precaution will prevent the set from becoming damaged due to its operation without a speaker load.

AUTOMATIC FREQUENCY CONTROL (AFC)

FM Broadcasting, by its very nature, eliminates almost all natural and man-made static. However, the characteristics of FM which make this possible also make for problems in tuning. The HARMAN-KARDON Recital II incorporates an effective Automatic Frequency

Control (AFC) circuit that overcomes these problems and insures proper tuning even if the manual tuning is not accurately done. The following experiment will lead to an understanding of AFC, and the fuller enjoyment of the Recital II.

Tune across the FM scale with the function switch into the FM-AFC position. Note how the stations "pop" into place. Now tune to any station, preferably one with a musical program. Defeat the AFC by tuning the function switch to the FM position, and tune slowly through the station from left to right. Notice that there are three points where the station sounds clean, interspersed with points of distorted sound. The middle clean-sounding point is the proper tuning position for the best tone quality with minimum noise and interference. Detune the station so that the sound is distorted. Turn the function switch to FM-AFC, and notice how the sound clears up.

Actually, the tuning has been readjusted by the operation of the AFC circuit, which automatically retunes the electronic circuits to the center of the station channel.

The AFC circuit of the Harman-Kardon Recital II performs the further function of overcoming any tendency of the tuner to drift.

In order to take maximum advantage of the benefits of AFC, it is suggested that fine tuning be done with the function switch in the FM position. When the switch is then turned to the FM-AFC position the AFC will improve this careful tuning by a factor of 10 to 1. This procedure is especially recommended in those cases where a weak station is found close to a strong station. Under these conditions, the AFC may tend to reach for the strong station, and completely skip over the weak station. If the weak station is tuned with the AFC defeated, the AFC will lock it in, after it has been reinserted.

OPERATING INSTRUCTIONS

A full understanding of the relationship among the Recital II operating controls will assure you realization of the rich potential of this excellent instrument.

The FUNCTION switch has nine positions: (EUR, RIAA, LP, Tape 7.5, Tape 3.75, AM, FM-AFC, FM, AUX). Its use is to select the desired type of program.

RECORD EQUALIZATION

In order to assure good reproduction of the wide range of frequencies in music and to make necessary adjustments for the limitations of the recording technique, record manufacturers have found it necessary to modify the actual frequency response of the music while it is being recorded. Thus, to avoid over-cutting and consequent distortion, a measured and deliberate reduction is effected in low frequency response by selecting a "turnover frequency" and by recording attenuated response below that point. To assure optimum signal-to-noise at the high frequency end when the rec-

ord is played at home, the highs are deliberately exaggerated during the recording process. A measured and deliberate boost is effected above a certain frequency. This combination of deliberate exaggeration at the low and high ends of the frequency response can be expressed in a "recording curve." When the record is played a mirror image of that curve should be available so that the ideal "flat" response may be achieved. Since several different recording curves have been used in the past (differing with respect to the turnover points and the degree of emphasis or deemphasis) a choice of playback curves is provided in Harman-Kardon instruments.

The three record equalization positions compensate for the characteristics of over 30 recording labels:

LP: Most American long playing records made before 1954 and some European LP's. Labels include: Columbia, London, Mercury, Oceanic, Remington, Tempo, Urania, Vanguard, Bach Guild, Vox, Westminster, RCA Victor (older), Atlantic, Decca, Polyphonic, Cetra-Soria, Esoteric, Haydn Society, MGM, Angel.

RIAA: Most American records made after 1954, all records cut to standards of Audio Engineering Society, NAB, new RCA Victor Ortho, and newly standardized RIAA. Labels include RCA Victor (newer), Extended Play 45, Blue Note Jazz, Canyon, Capitol, Good Time Jazz, Mercury, some London, Bartok, Caedman, Capitol-Cetra, Philharmonic, EMS.

EUR: Most European long playing, some American LP's and most 78 RPM discs.

The LOUDNESS control is used to adjust the volume of any program. Its effect is selectively varied by the

DYNAMIC CONTOUR CONTROL

One of the limitations of human hearing is its tendency to lose sensitivity to the very low and very high pitched sounds, as the sound level is reduced. It is this characteristic (known as the Fletcher-Munson effect) which causes one to play music programs at high level in order to experience the fullness of tone available from fine modern recordings and identified with "live" listening. The Harman-Kardon Dynamic Loudness Contour Control compensates for the Fletcher-Munson effect, eliminating high reproduction level as a requisite for full enjoyment of reproduced music. Three positions of compensation are provided, to allow the selection of the one most suited to your hearing.

Each position causes the loudness (Volume) control to perform with a different degree of compensation, the amount increasing with each clockwise setting. Position "0" is uncompensated. Position 1 provides somewhat less compensation than that required to match the Fletcher-Munson loudness contour curves. Position 2 provides compensation that approximates the suggested curves. Since hearing characteristics vary from person to person (some require more and others less compensation), the flexibility provided in these controls can be appreciated.

In operation, the proper choice of contour is easily made, by switching through the several loudness contour positions and selecting the one which sounds best to you.

Separate BASS and TREBLE controls are incorporated in the Recital II, to provide the full range of adjustment required for satisfactory high fidelity performance.

RUMBLE FILTER

Many records, record changers and turntables produce an objectionable low frequency signal that is often strong enough to be picked up by the phono cartridge and introduced into the playback system. Known as "rumble" this undesirable signal can be eliminated in the Recital II by the use of the Rumble Filter which is controlled by a three position slide switch located on the front panel. In position 0 the rumble filter is not connected and frequency response is essentially flat to 20 c.p.s. When the switch is placed in position 1 the response is slowly rolled off and at 20 c.p.s. is reduced by 6 db. Frequency response is reduced by 12 db at 20 c.p.s. when the switch is placed in position 2. Position 1 will be most useful where a minimum amount of rumble appears in the system while position 2 gives additional low frequency attenuation which will be most helpful in cases of heavy rumble.

ORGANIZING THE VARIOUS CONTROLS

In general, every control on a well designed, honestly considered high fidelity instrument has a specific useful function, related to each of the other controls. Although this cannot be a full treatise on the subject, an explanatory note on the relationship of the various front panel controls will doubtless prove useful in organizing and clarifying them for the user.

Beginning with the function selector, choose the type of program material you plan to listen to (tuner, phono, etc.). Choose the correct record equalization setting for the particular record you are to play. With Loudness Contour Selector in the uncompensated position, turn the loudness (volume) control to as high a level as you can briefly allow. (This to permit you to make the remaining adjustments while you are listening at your own maximum efficiency.) Now adjust the Bass and Treble Tone Controls to correct for the electro-mechanical characteristics of the loudspeaker you are using and for the acoustic characteristics of the room in which you are listening.

Modify each until settings are chosen which in your total system create the proper sense of aural balance and evenness. Now reduce the loudness (volume) control setting to a level somewhat lower than normal listening level in your room. You will note that the full bodied-lifelike quality you experienced at high listening level has disappeared (this because of the Fletcher-Munson effect described in the paragraph on the H/K Dynamic Loudness Contour). With all other controls unchanged, select the best contour setting for you. Do this by switching quickly through the several positions until you find the one which most nearly du-

plicates the full bodied sound you enjoyed at high level. Now turn the loudness control up to the level at which you wish to listen - (perhaps the maximum level you can permit in your home) - and listen. You'll find that there is automatic compensation of contour wherever you set the loudness control thereafter. In fact, under normal circumstances, you should not find it necessary to readjust the tone controls or the contour selector once having chosen the correct settings for you, your room and your system.

HUM PROBLEMS

In some installations where a record-player, tape recorder, or other auxiliary AC operated equipment is used, hum may be encountered due to voltage differences between the various units. This may be eliminated by reversing one or all of the AC power plugs. Simply reverse one at a time until improvement is experienced.

MAINTENANCE AND REPAIR

Due to the conservative design and high quality components of the Recital II, no routine maintenance other than yearly tube-checking is required. Should trouble develop, however, only the most qualified service man should be employed, as special equipment and training is required to properly align a high fidelity FM receiver.



WARRANTY:

We warrant each Recital II, Model TA-120 to be free from defects in material and workmanship under normal use and service, and in accordance with the conditions herein below set forth, for a period of 90 days from date of delivery to the original purchaser, and agree to replace or repair any part or parts returned to us within said 90 days, with transportation prepaid, and which our examination shall disclose to our satisfaction to have been thus defective. This warranty does not include free labor, nor is it applicable to any instrument which shall have been repaired or altered in any way so as in our judgment to affect its stability or reliability nor which has been subject to neglect, misuse, abuse, negligence or accident nor which has had the serial number altered, effaced, or removed. Neither shall this warranty apply to any instrument which has been connected otherwise than in accordance with the instructions furnished by us.

This warranty is expressly in lieu of all other warranties, express or implied, and of all other obligations or liabilities on our part, and we neither assume nor authorize any representative or other person to assume for us any other liability in connection with the sale of the Model TA-120 Recital II.

SERVICE NOTES

Servicing printed circuits is a simple matter and is no more complicated than servicing conventionally wired circuits.

Printed circuit receivers, can be more easily repaired, if certain precautions are observed. Standard components are used throughout and can be removed and replaced by any serviceman. No special tools or skills are necessary. However, some parts which have special mounting and connection lugs should be replaced with exact duplicate parts.

AVOID DAMAGE TO COPPER FOIL

Be careful when removing components from the board. However, if the copper foil wiring is damaged a piece of wire can be used to replace the damaged foil. Small breaks can be "jumped" with molten solder. Larger breaks can be repaired with ordinary hook up wire. It is unnecessary to replace the entire board because of foil breakage.

AVOID DAMAGE TO PRINTED CIRCUIT BOARD

Do not apply excessive pressure to the printed circuit board or components. This is especially important to note when changing tubes. Although the board is sturdy in construction and mounting, it may crack or break if proper care is not taken when servicing. In case the board is to be removed from the chassis, remove the mounting screws around the edges and unsolder the few leads that connect between the board and the chassis. If this is done, a vise with protected jaws should be used to hold the board while servicing and care should be taken not to exert excessive pressure against the board.

AVOID EXCESSIVE DEPOSITS OF SOLDER

In some areas on the printed circuit board, the wiring is very closely spaced. When resoldering a new component avoid excessive deposits of solder. Excessive solder may cause a short or an intermittent trouble to occur later which may be difficult to locate.

AVOID OVERHEATING

When using the soldering iron (35 watts or less), do not overheat the component terminals or the copper foil. Excessive heat (applying soldering iron longer than necessary, using a higher wattage soldering iron than recommended, or using a solder gun) may cause the bond between the board and foil to break. This will necessitate replacement or repair of the foil connection.

TOOLS AND MATERIALS REQUIRED

- (1) Low wattage soldering iron with a small point or wedge (rating should not exceed 35 watts).
- (2) Small wire brush.

- (3) 60% tin, 40% lead, low temperature rosin core solder.
- (4) Thin bladed knife.
- (5) Small wire pick, or soldering aid.

REPLACING COMPONENTS

SOLDERING REPLACEMENT COMPONENT TO OLD LEADS

Cut the leads where they enter the defective component. Clean off the ends of the leads, leaving as much of the leads as possible. Make a small loop in each lead of the replacement component and slide the loops over the remaining leads of the old component. Caution should be taken not to overheat the connection since the copper foil may peel or the original component lead may fall out of the board. This is possible due to heat transfer through the leads. The lead length of the replacement part should be kept reasonably short to provide some mechanical rigidity.

UNSOLDERING AND RESOLDERING COMPONENTS

To test a component or if the component is mounted in such a manner that the above method can not be used (such as vertically mounted capacitors, etc.) the component can be replaced by unsoldering it. This procedure should be used whenever it is necessary to unsolder any connections to replace defective components.

(a) Heat the connection on the wiring side of the board with a small soldering iron. When the solder melts, brush away the solder. Do not overheat the connection. In the process of removing the solder, caution must be taken to prevent excessive heating. Therefore, do not leave the iron on the connection while brushing away the solder. Melt the solder, remove the iron and quickly brush away the solder. It may require more than one heating and brushing process to completely remove the solder.

(b) Insert a knife blade between the wiring foil and the "bent-over" component lead and bend the lead perpendicular to the board. (It may be necessary to apply the soldering iron to the connection while performing this step as it is sometimes difficult to completely break the connection by brushing.) Do not overheat the connection.

(c) While applying the soldering iron to the connections, "wiggle" the component until it is removed.

(d) Remove any small particles of solder using a clean cloth dipped in solvent.

(e) A thin film of solder may remain over the hole through the board after removing the component. Pierce the film with the lead from the new component after heating the solder film with the soldering iron.

(f) Insert the leads of the new component through the holes provided. Cut to desired length and bend over the ends against the copper foil. Resolder the connection with 60/40 low temperature solder.

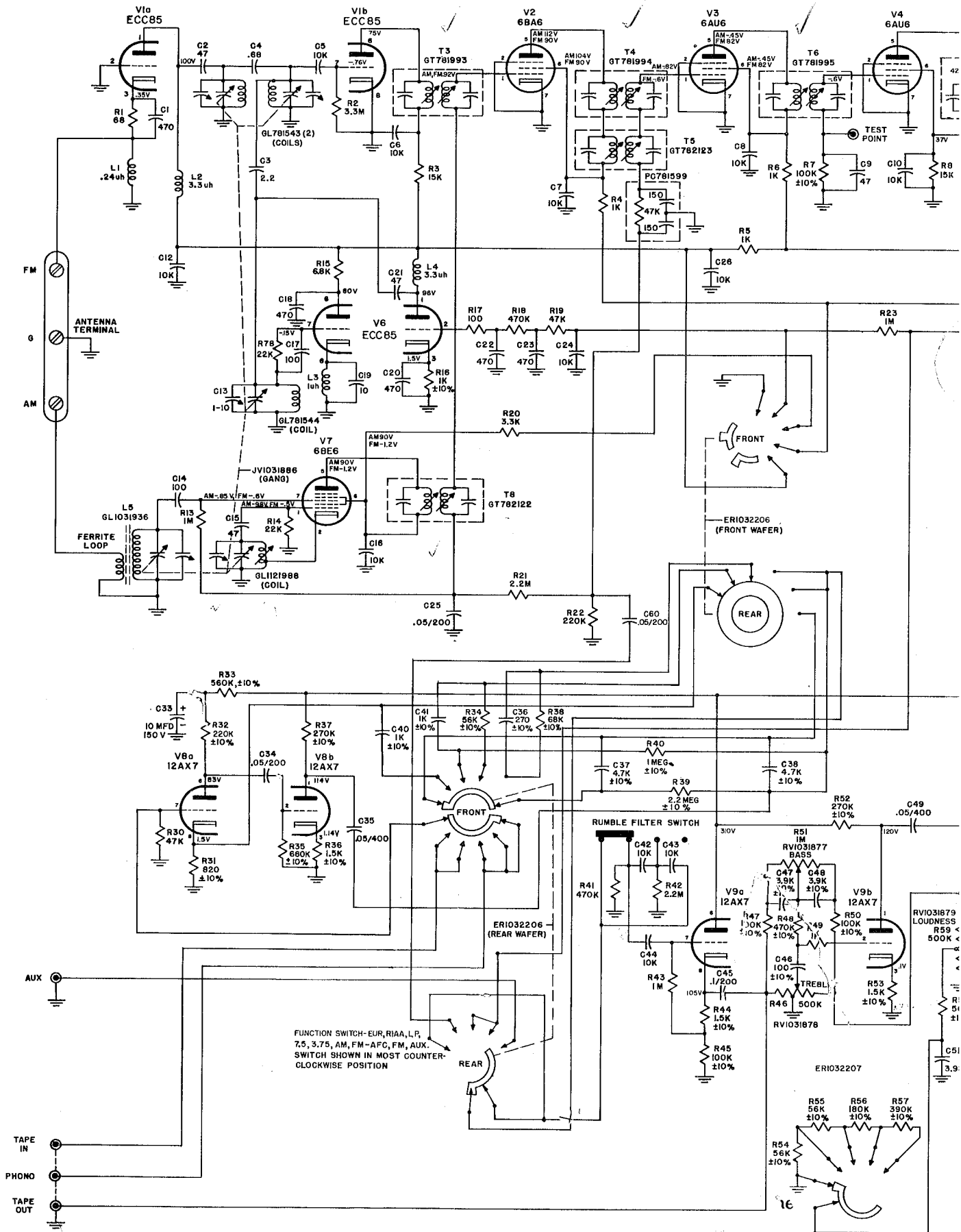

SCHEMATIC

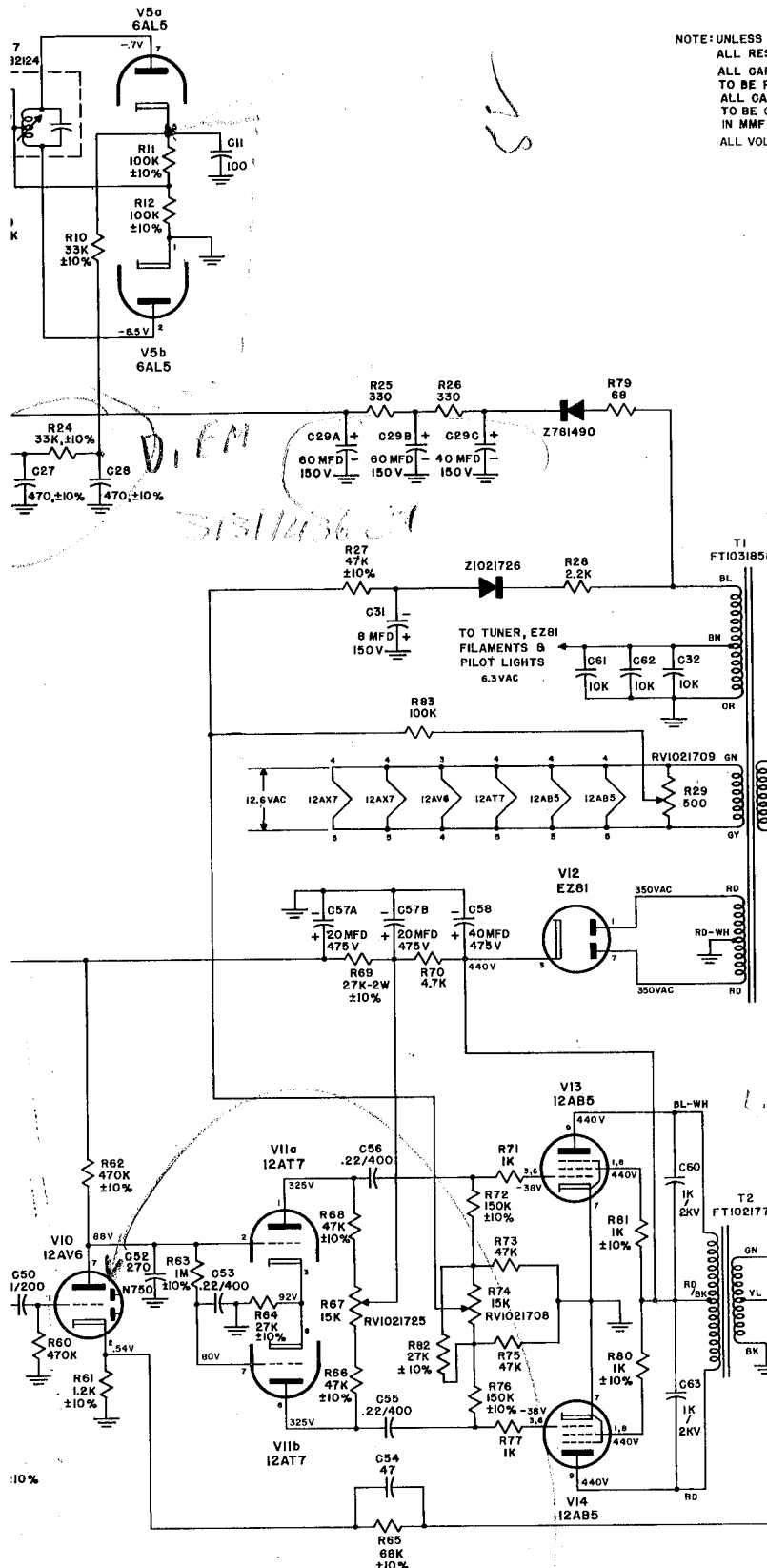

NOTE: UNLESS OTHERWISE SHOWN
 ALL RESISTORS $\frac{1}{2}$ WATT $\pm 20\%$
 ALL CAPACITOR VALUES WITH DECIMAL POINT
 TO BE PAPER, IN MFD
 ALL CAPACITOR VALUES WITHOUT DECIMAL POINT
 TO BE GENERAL PURPOSE CERAMICS 500 WVDC,
 IN MMF
 ALL VOLTAGES ARE DC

RESISTANCE CHART

TUBE	1	2	3	4	5	6	7	8	9
V1 ECC85	3.4M	22K				35K			
V2 6BA6	AM 2.2M					28K	28K		
V3 6AU6	AM 220K					28K	28K		
V3 6AU6	FM 220K					2.4K	2.4K		
V4 6AU6	100K					14K	14K		
V5 6AL5		75K				120K		75K	
V6 ECC85	25K	450K	1000			26K	70K		
V7 6BE6	AM 1.8M					480K	480K	3M	
V7 6BE6	FM 20K							3M	
V8 12AX7	1.1M	240K	1500			1.2M	40K	2100	
V9 12AX7	1.8M	630K	1500			1.5M	1M	100K	
V10 12AV6	450K	1.2M				NC	NC	1M	
V11 12AT7		1.4M	27K					2M	27K
V12 EZ81	150							140	
V13 12AB5	750K	170K				170K	0	750K	750K
V14 12AB5	750K	170K				170K	0	750K	750K

CONTOUR SWITCH-0,1,2,3,4,5
 SWITCH SHOWN IN MOST COUNTER-
 CLOCKWISE POSITION

POS | SPEAKER

1	A
2	AB
3	B

DIAGRAM

Handwritten notes:
 Short diodes
 Part 566



by readings

201157
78193A

GT 781995

GT 782124

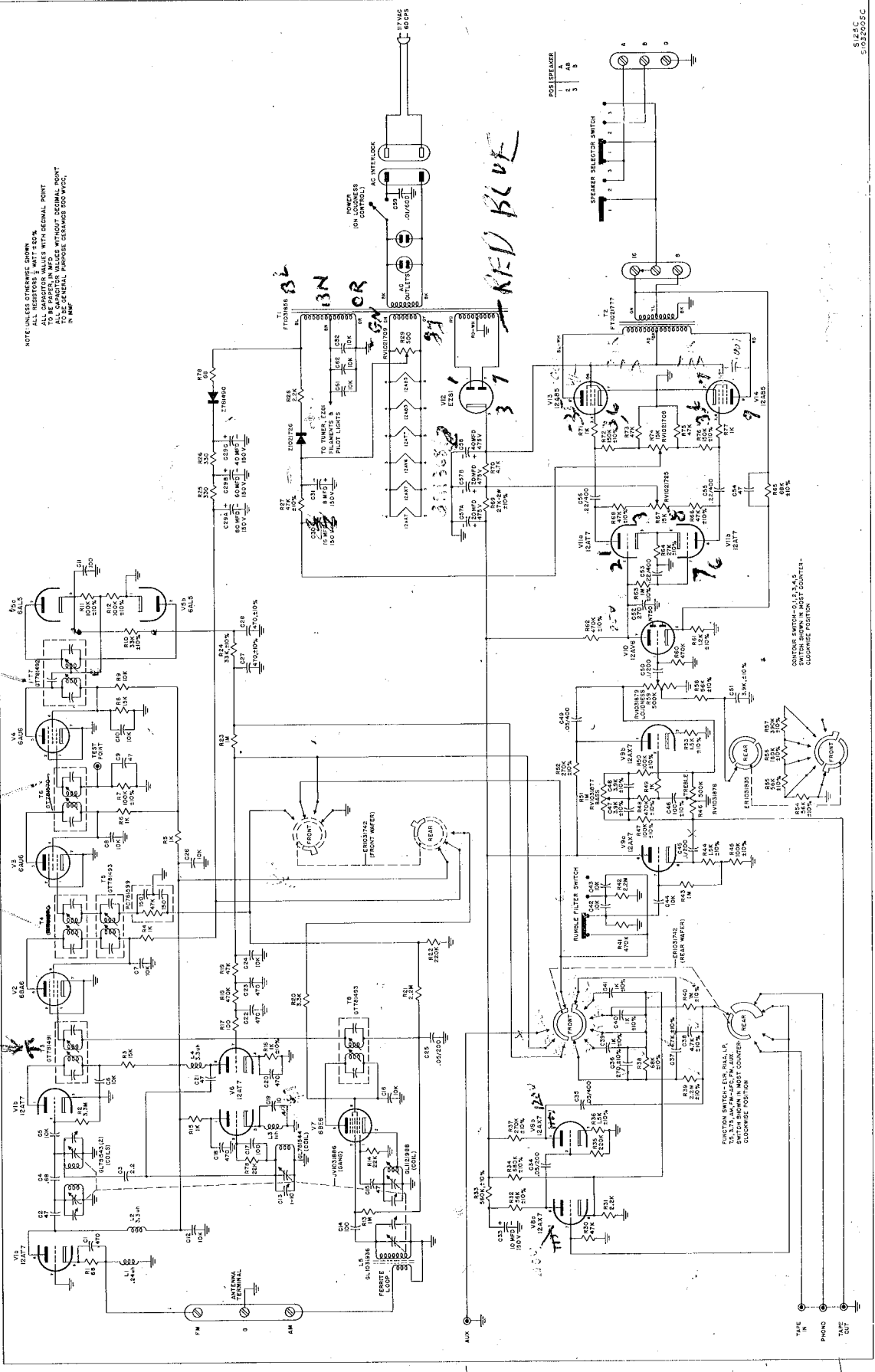

SCHEMATIC DIAGRAM MODEL TA-120 RECITAL II

55 60
 20 watts
 2% I.M.
 Re Hum - 80
 Re Aury - 70
 Phon - 60
 BB below 80
 " " " " " "

51423C
5020255C

These photographs show the printed circuit boards used in the Harman-Kardon Recital II and indicate to some degree the complexity of design and painstaking care required in the planning of such a unit.

FM frequencies, by their very nature, require careful placement of parts and leads. In conventional point to point wiring, misplacement of a wire, even a slight amount from its correct position will adversely affect operation.

The amplifier has been designed to use printed circuits in those areas where each component and each connecting lead must be carefully positioned in order to afford best possible operation.

This design form results, we feel, in providing the best possible characteristics and reflects the highest state of the art in the construction of fine audio equipment.

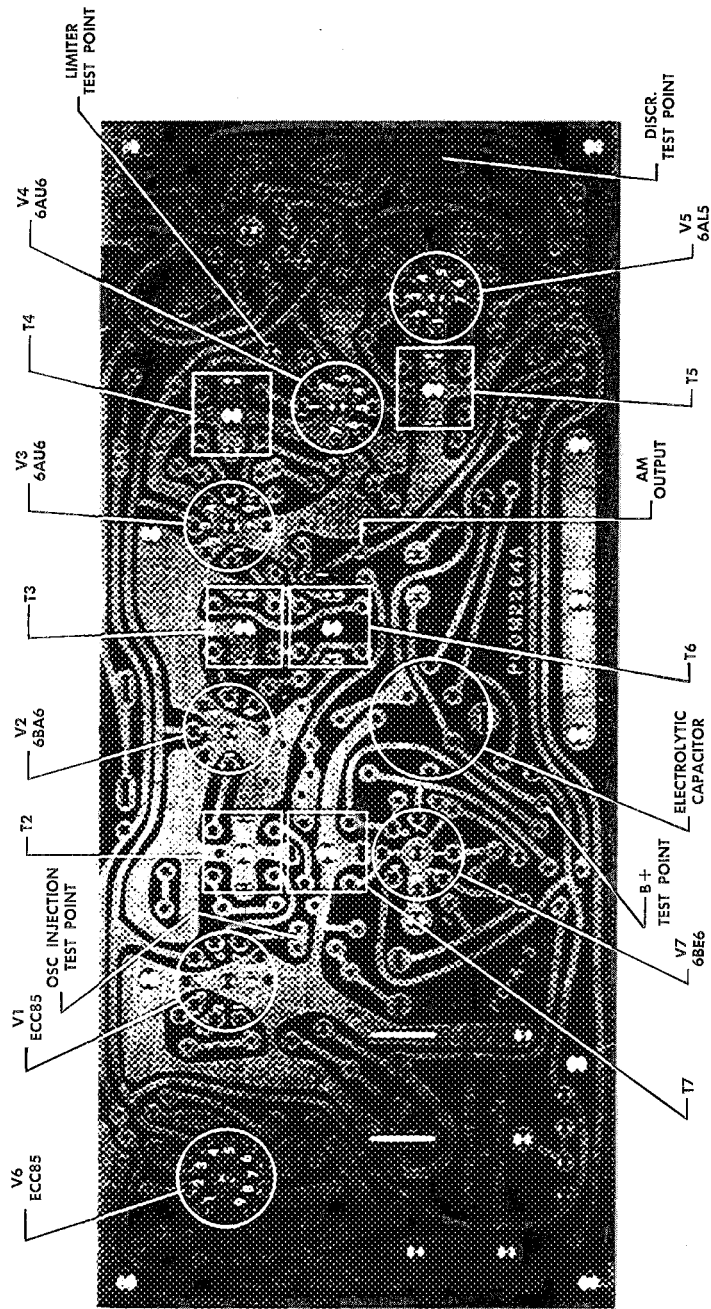
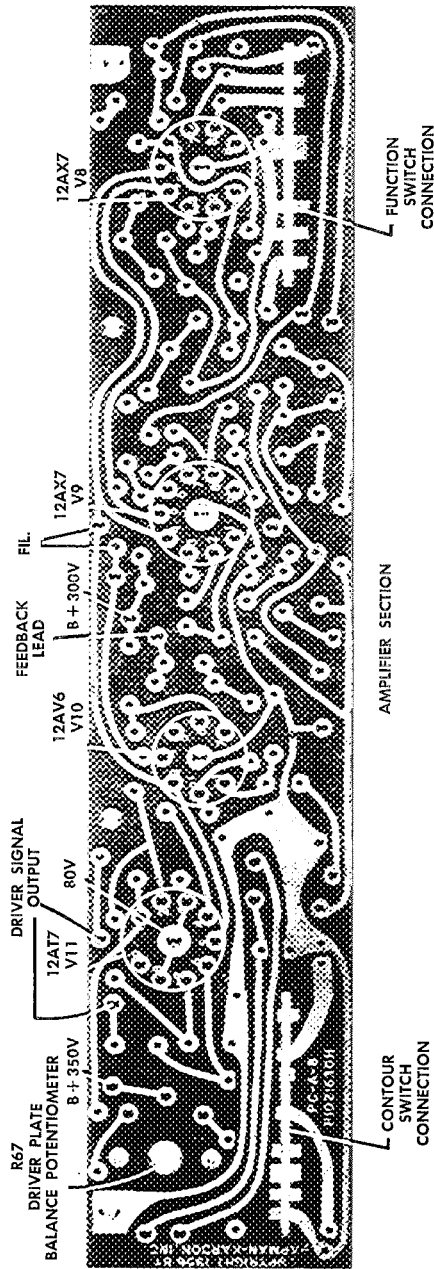

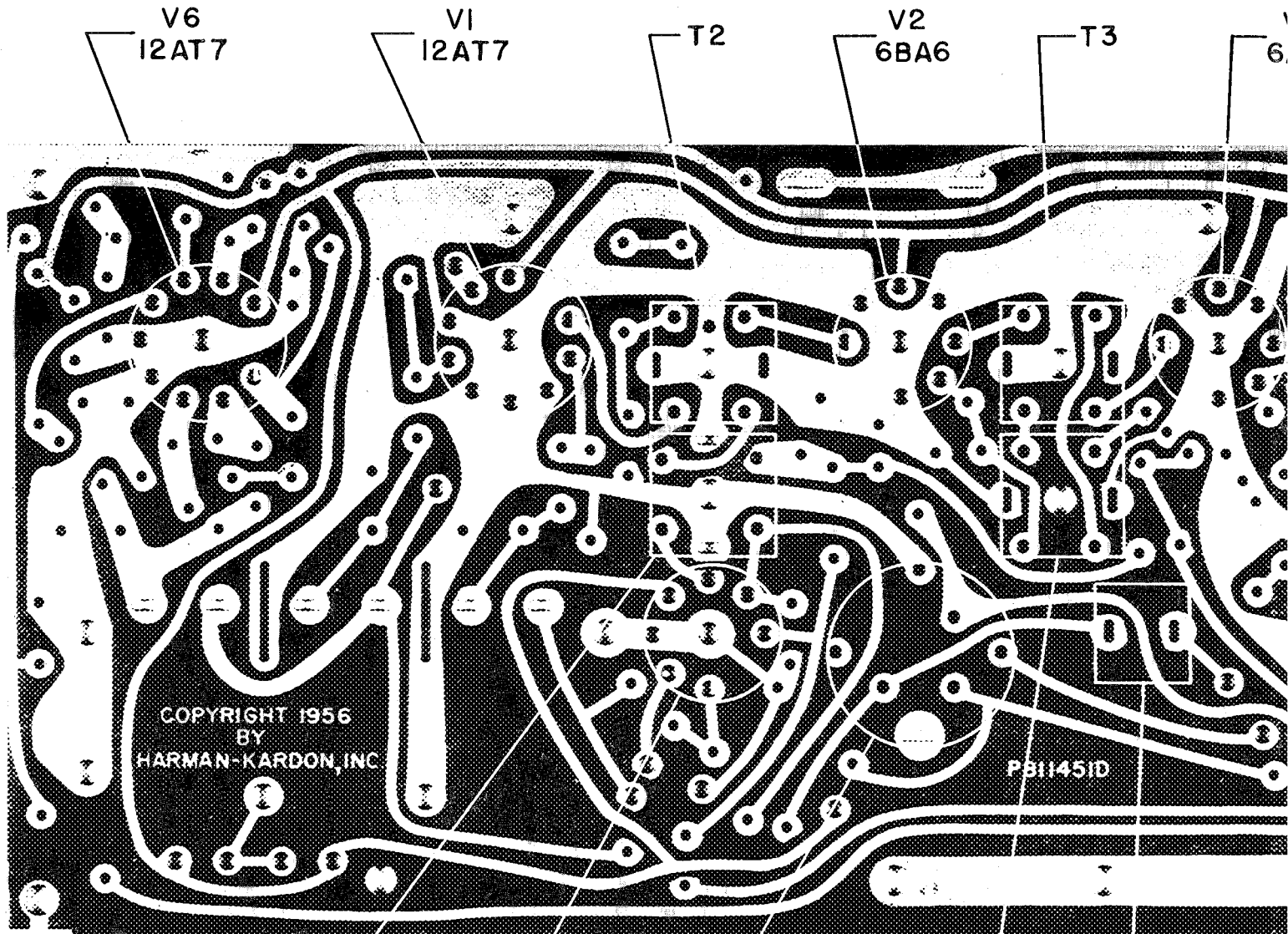

REPRODUCTION FORBIDDEN

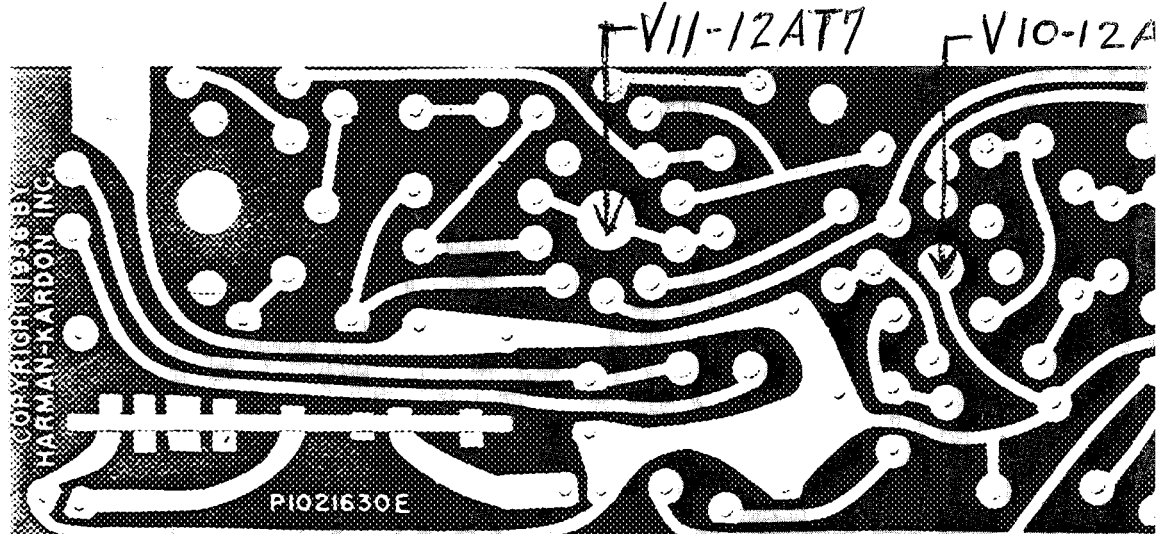

REPRODUCTION FORBIDDEN

6

T4

V4
6AU6

CONSTRUCTION SHEET
MODEL TA-120
RECITAL II

These photographs show the printed circuit boards used in the Harman-Kardon Recital II and indicate to some degree the complexity of design and painstaking care required in the planning of such a unit.

FM frequencies, by their very nature, require careful placement of parts and leads. In conventional point to point wiring, misplacement of a wire, even a slight amount from its correct position will adversely affect operation.

The amplifier has been designed to use printed circuits in those areas where each component and each connecting lead must be carefully positioned in order to afford best possible operation.

This design form results, we feel, in providing the best possible characteristics and reflects the highest state of the art in the construction of fine audio equipment.

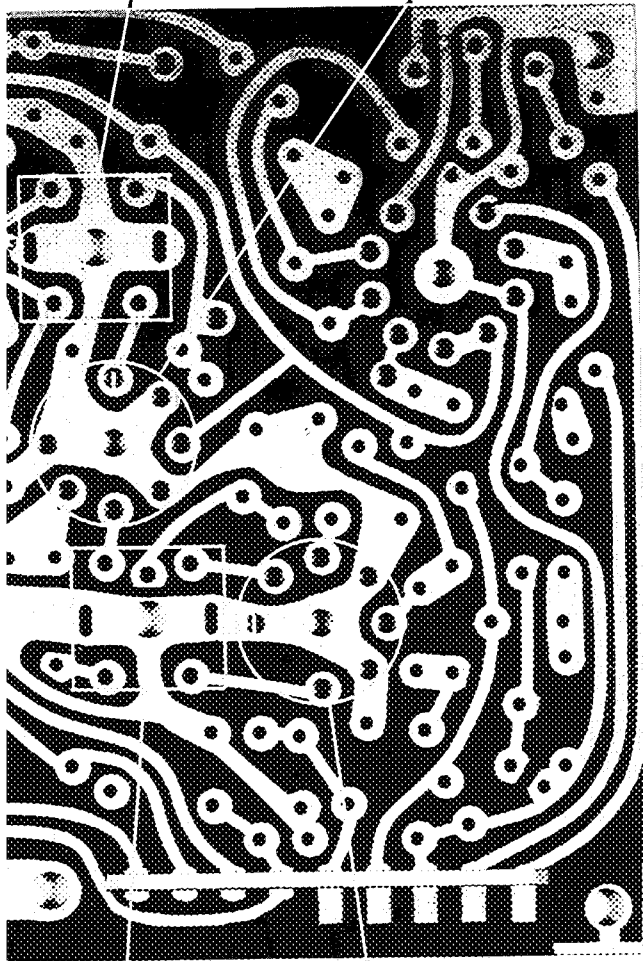

TUNER SECTION

M
R

T5

V5
6AL5

16

V9 - 12AX7

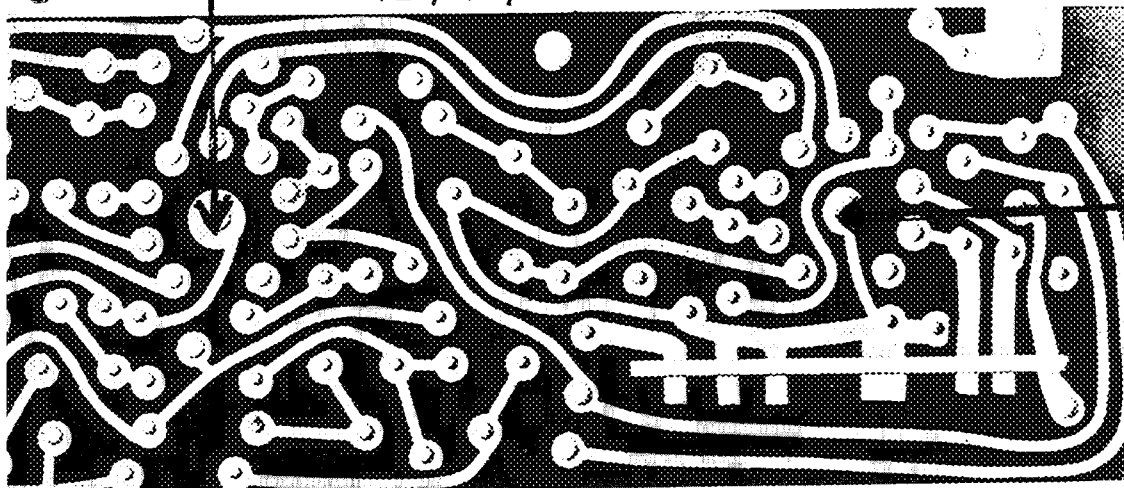

AMPLIFIER SECTION

FOR OTHER
INFO ON AMP
BOARD SEE
A 120 DIAG.

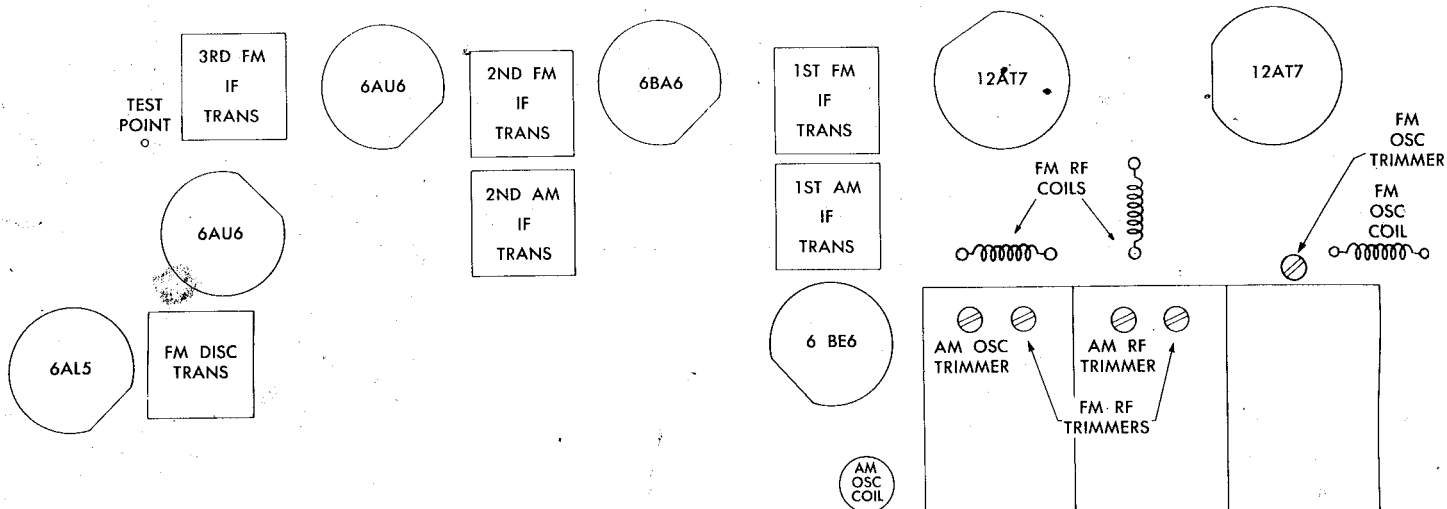

TRIMMER & TUBE LOCATION MODEL TA-120

TOP VIEW (FRONT)

FUNCTION SWITCH SETTING	SIGNAL GENERATOR		SIGNAL INPUT POINT	OUTPUT INDICATOR	CONNECT INDICATOR TO:	DIAL SETTING	ADJUST	OUTPUT INDICATION
	FREQ.	MOD.						
AM	455 KC	30% AM	AM-RF GANG	AC-VTVM OR SCOPE	TUNER OUTPUT	1600 KC	2 AM IF TRANS.	MAXIMUM OUTPUT
AM	1400 KC	30% AM	AM ANT. TERM.	AC-VTVM OR SCOPE	TUNER OUTPUT	1400 KC	OSC & ANT TRIMMERS	MAXIMUM OUTPUT
AM	600 KC	30% AM	AM ANT. TERM.	AC-VTVM OR SCOPE	TUNER OUTPUT	600 KC	OSC COIL & LOOPSTICK	MAXIMUM OUTPUT
AM	1400 KC				REPEAT STEP 2			

AM ALIGNMENT PROCEDURE

FUNCTION SWITCH SETTING	SIGNAL GENERATOR		SIGNAL INPUT POINT	OUTPUT INDICATOR	CONNECT INDICATOR TO:	DIAL SETTING	ADJUST	OUTPUT INDICATION
	FREQ.	MOD.						
FM	10.7 MC	300KC FM 60 CPS	FM MIXER GANG	AC-VTVM OR SCOPE	TEST POINT	—	3 FM IF TRANS.	MAX GAIN & SYMMETRY
FM	10.7 MC	300KC FM 60 CPS	FM MIXER GANG	AC-VTVM OR SCOPE	TUNER OUTPUT	—	DISCR. TRANS.	S PATTERN OF MAX GAIN & SYMM.
FM	106 MC	300KC FM 60 CPS	FM ANT. TERMINAL	AC-VTVM OR SCOPE	TEST POINT	106 MC	106 MC OSC RF, MIXER TRIMMERS	MAXIMUM OUTPUT
FM	90 MC	300KC FM 60 CPS	FM ANT. TERMINAL	AC-VTVM OR SCOPE	TEST POINT	90 MC	OSC, RF, MIXER COILS	MAXIMUM OUTPUT

FM ALIGNMENT PROCEDURE

SPECIFICATIONS

RF SECTION

Circuits: FM: Armstrong circuit with Limiter & Foster-Seeley Discriminator. Automatic Frequency Control—Low Noise Front End consisting of Triode Grounded Grid Amplifier and Triode Mixer. AM: Superheterodyne with A.V.C. and Ferrite Antenna.
Sensitivity: FM: 5 microvolts for 30 db quieting; 3 microvolts for 20 db quieting. AM: Loop sensitivity 80 microvolts/meter; External antenna sensitivity 20 microvolts.
Selectivity: FM: IF Bandwidth: 200 KC at 6 db down.
Discriminator—375 KC, peak to peak.
AM—8 KC bandwidth at 6 db down.
Frequency Range: FM: 88-108 MC AM: 530-1650 KC
FM Drift: ±5 KC max.
Image Rejection: FM: 40 db AM: 30 db
Antenna Input: FM: 300 ohms
AM: Built-in low noise ferrite loopstick plus high impedance terminal for external antenna.
Distortion: Less than 1% harmonic on FM.
 Less than 1% harmonic for up to 80% mod. on AM.
Frequency Response: FM ± ½ db 20 to 20,000 c.p.s. including standard 75 microsecond deemphasis.
AM: 3 db 20 to 5,000 c.p.s.
Hum Level: 60 db below 100% modulation.
Radiation: Within FCC requirements.

AUDIO SECTION

Circuits: Output circuit employs 2 #12AB5 in new high efficiency, low heat generating circuit.
Power Output: 20 watt at 2% IM (40 & 7,000 cycles)
Peak Power: 30 watts
Frequency Response:
 ±1 db, 20—20,000 c.p.s. at 20 watts ±1/2 db, 20—20,000 at 10 watts.
Damping Factor: 20
Output Impedance: 8 and 16 ohms
Hum: Min. volume hum: 80 db below 20 watts.
 Aux, and tuner hum: 70 db below 20 watts.
 Phono hum (in RIAA position): 60 db below 20 watts.
Tone Control Range: ±16 db at 50 and 10,000 c.p.s.
Input Levels: Aux. 0.3 volts, Phono: 6 millivolts
Rumble Filter: 3 Positions: Off, 6 db per octave cut below 50 cycles, 6 db per octave cut below 100 cycles.
Dynamic Loudness Contour: 6 Positions:
 Position 1: Uncompensated
 Position 2: Approximately 10 db less than Fletcher-Munson
 Position 3: Approximately 5 db less than Fletcher-Munson
 Position 4: Fletcher-Munson compensation
 Position 5: Approximately 5 db more than Fletcher-Munson
 Position 6: Approximately 10 db more than Fletcher-Munson

OVERALL SPECIFICATIONS

Controls: (Total 8) Tuning, Loudness, Bass, Treble, Function (EUR, RIAA, LP, Tape 7.5, Tape 3.75, AM, FM-APC, FM, AUX), Contour, Speaker Selector, Rumble Filter.
Dimensions: 14-3/4" wide x 3-5/8" high x 10-15/16" deep (including loopstick—not including knobs)
Tube Complement: (Total: 14) 3-12AT7, 1-6BE6, 1-6BA6, 2-6AU6, 1-6AL5, 2-12AX7, 1-12AV6, 2-12AB5, 1-EZ81, plus 2 selenium rectifiers.
Installation Space Required: 15" wide, 4-1/4" high, 11-1/4" deep
Power Consumption: 70 watts at zero output
 100 watts at rated output
 75 watts at average program level

Shipping Weight: 22 lbs.
Finish: Escutcheon and cage: brushed copper—Display panel for escutcheon and knobs: matte black—Edge lighted dial glass: yellow and white.
Functional Features:
 (a) Counterweighted Tuning Control
 (b) Tape Output Receptacle furnished on chassis rear prior to tone controls.
 (c) Rumble Filter

SPECIAL NOTES

- Safety Interlock Power Cord disconnects power when cage is removed.
- Printed circuits used throughout, employs dip soldered copper-clad laminated phenolic plastic board.
- Simple mechanical disassembly makes boards easily available for service.
- Face up mounting permissible without special precaution.
- Hardware and Accessory Material Furnished: Cabinet mounting screws, Template, Instruction booklet, FM antenna wire.
- Brass finished escutcheon and cage available on special order.

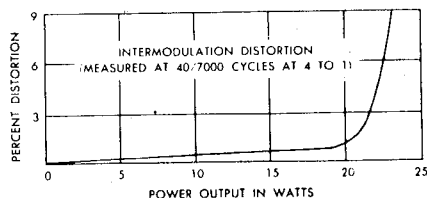

Intermodulation distortion characteristics

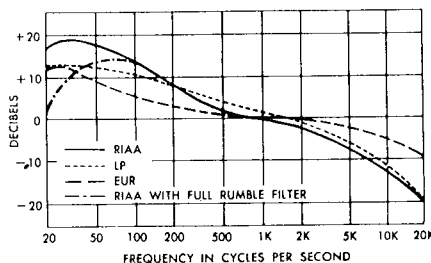

Phonograph equalization characteristics

LIST OF REPLACEABLE PARTS

DESCRIPTION	HARMAN-KARDON PART NO.	PRICE
Output Transformer	FT1021707	\$19.60
Power Transformer	FT1031858	14.75
Antenna Loopstick	GL781479	2.30
Loopstick Tuning Ring	P481329	.15
Pointer	P1031864	.30
Dial Glass Assembly	P1031863	.80
Capacitor 40/475 V.	JE1071739—	2.60
Capacitor 20, 20/475 V.	JE1071740—	2.95
Function Switch	ER1031742	4.50
Contour Switch	ER1021632	2.55
Variable Condenser	JV1031886	8.25
Selenium Rectifier	Z781490	1.65
FM IF Transformer	GT781491	1.60
FM IF Transformer	GT781570	1.45
FM Disc. Transformer	GT781492	2.00
AM IF Transformer	GT781493	1.50
Oscillator Trimmer	JV20688	.30
Escutcheon	B1031867	7.50
Bass Control	RV1031877	.85
Treble Control	RV1031878	.85
Loudness Control	RV1031879	1.35
Cage		8.50
Knob	P22783	.15
Knob	P20778	.15
Instruction Sheet	L1031875	.75
Mounting Template	L1031876	.15

Ref. 40, 60, 60/1500 JE781436

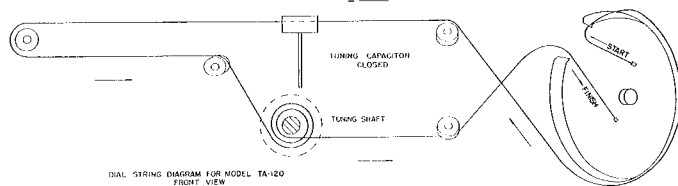

DIAL CORD DRIVE

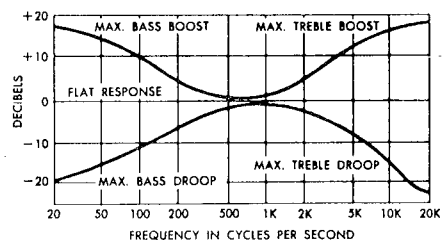

Tone control and frequency response characteristics

SPECIFICATIONS

RF SECTION

Circuits: FM: Armstrong circuit with Limiter & Foster-Seeley Discriminator. Automatic Frequency Control—Low Noise Front End consisting of Triode Grounded Grid Amplifier and Triode Mixer. AM: Superheterodyne with A.V.C. and Ferrite Antenna.

Sensitivity: FM: 5 microvolts for 30 db quieting; 3 microvolts for 20 db quieting. AM: Loop sensitivity 80 microvolts/meter; External antenna sensitivity 20 microvolts.

Selectivity: FM: IF Bandwidth: 200 KC at 6 db down.

Discriminator—375 KC, peak to peak.

AM—8 KC bandwidth at 6 db down.

Frequency Range: FM: 88-108 MC AM: 530-1650 KC

FM Drift: ± 5 KC max.

Image Rejection: FM: 40 db AM: 30 db

Antenna Input: FM: 300 ohms

AM: Built-in low noise ferrite loopstick plus high impedance terminal for external antenna.

Distortion: Less than 1% harmonic on FM.

Less than 1% harmonic for up to 80% mod. on AM.

Frequency Response: FM $\pm 1/2$ db 20 to 20,000 c.p.s. including standard 75 microsecond deemphasis.

AM: 3 db 20 to 5,000 c.p.s.

Hum Level: 60 db below 100% modulation.

Radiation: Within FCC requirements.

AUDIO SECTION

Circuits: Output circuit employs 2 #12AB5 in new high efficiency, low heat generating circuit.

Power Output: 20 watt at 1% IM (40 & 7,000 cycles)

Peak Power: 30 watts.

Frequency Response: ± 1 db, 20—20,000 c.p.s. at 20 watts $\pm 1/2$ db, 15—40,000 at 10 watts.

Damping Factor: 20.

Output Impedance: 8 and 16 ohms.

Hum: Min. volume hum: 80 db below 20 watts.

Aux. and tuner hum: 70 db below 20 watts.

Phono hum (in RIAA position): 60 db below 20 watts.

Tone Control Range: ± 16 db at 50 and 10,000 c.p.s.

Input Levels: Aux. 0.3 volts, Phono: 3 millivolts. Tape: 1.5 mv.

Rumble Filter: 3 Positions: Off, 6 db per octave cut below 50 cycles, 6 db per octave cut below 100 cycles.

Dynamic Loudness Contour: 6 Positions:

Position 1: Uncompensated.

Position 2: Approximately 10 db less than Fletcher-Munson.

Position 3: Approximately 5 db less than Fletcher-Munson.

Position 4: Fletcher-Munson compensation.

Position 5: Approximately 5 db more than Fletcher-Munson.

Position 6: Approximately 10 db more than Fletcher-Munson.

SPECIAL NOTES

- (a) Safety Interlock Power Cord disconnects power when cage removed.
- (b) Printed circuits used throughout, employs dip soldered copper-clad laminated phenolic plastic board.

- (c) Simple mechanical disassembly makes boards easily available for service.
- (d) Face up mounting permissible without special precaution.
- (e) Hardware and Accessory Material Furnished: Cabinet mounting screws, Template, Instruction booklet, FM antenna wire.

OVERALL SPECIFICATIONS

Controls: (Total: 8) Tuning, Loudness, Bass, Treble, Function (EUR, RIAA, LP Tape 7.5, Tape 3.75, AM, FM-AFC, FM, AUX), Contour, Speaker Selector, Rumble Filter.

Dimensions: 14-3/4" wide x 3-5/8" high x 10-15/16" deep including loopstick—not including knobs).

Tube Complement: (Total: 14) 2-ECC-85, 1-2AT7, 1-6BE6, 1-6BA6, 2-6AU6, 1-6AL5, 2-12AX7, 1-12AV6, 2-12AB5, 1-EZ81, plus 2 selenium rectifiers.

Installation Space Required: 15" wide, 4-1/4" high, 11-1/4" deep.

Power Consumption: 70 watts at zero output.

100 watts at rated output.

75 watts at average program level.

Shipping Weight: 22 lbs.

Finish: Escutcheon and cage: brushed copper—Display panel for escutcheon and knobs: matte black—Edge lighted dial glass: yellow and white.

Functional Features:

- (a) Counterweighted Tuning Control.
- (b) Tape Output Receptacle furnished on chassis rear prior to tone controls.
- (c) Rumble Filter.

LIST OF REPLACEABLE PARTS

DESCRIPTION	HARMAN-KARDON PART NO.	PRICE
Output Transformer	FT1021777	\$19.60
Power Transformer	FT1031858	14.75
Antenna Loopstick	GL781479	2.30
Loopstick Tuning Ring	P481329A	.15
Pointer	P1031864A	.30
Dial Glass Assembly	P1031863A	.80
Capacitor 40/475 V.	JE1071739	2.60
Capacitor 20, 20/475 V.	JE1071740	2.95
Function Switch	ER1032206A	4.50
Contour Switch	ER1032207A	2.55
Variable Condenser	JV1031886	8.25
Selenium Rectifier	Z781490	1.65
FM IF Transformer	GT781491	1.60
FM IF Transformer	GT781570	1.45
FM Disc. Transformer	GT781492	2.00
AM IF Transformer	GT781493	1.50
Oscillator Trimmer	JV20688	.30
Escutcheon	B1031867A	7.50
Bass Control	RV1031877	.85
Treble Control	RV1031878	.85
Loudness Control	RV1031879	1.35
Cage	P1031873	8.50
Knob	P22783	.15
Knob	P20778	.15
Instruction Sheet	L1031875	1.00
Mounting Template	L1031876	.75
Schematic		.50